

SCS DAV PUBLIC SCHOOL
HAVELI KHARAGPUR

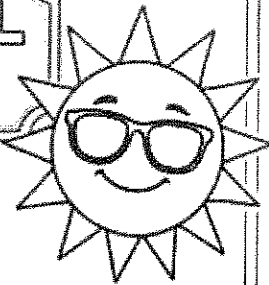

SUMMER VACATION

HOMESCHOOL

♡ Session 2026 - 2027 ♡

Name : _____
Class : _____
Section : _____
Roll No. : _____
School : _____

Summer is the time to relax,
refresh and recharge your mind
with new ideas and positivity.

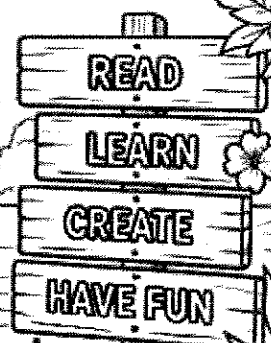

NOTE: Homework is a part of learning.
Complete and submit it on time.

Holiday Homework Guidelines

① Do all work neatly.

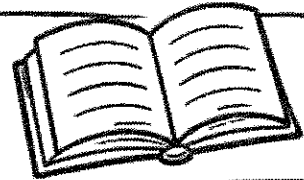

② Revise all work daily.

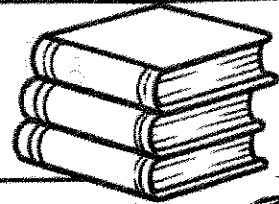

③ Colour the picture by using crayons and pencil colours.



④ Complete the work with parents' help.

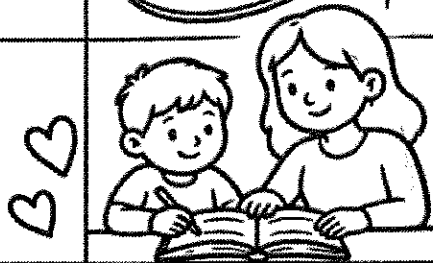

⑤ Submission of Homework is compulsory for all students and on time.

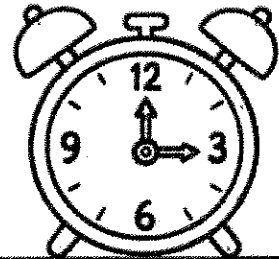

⑥ Bind and staple all pages and submitted in a file.

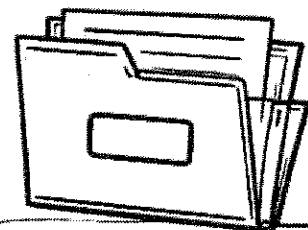

Children will take care of themselves at home and behave well.

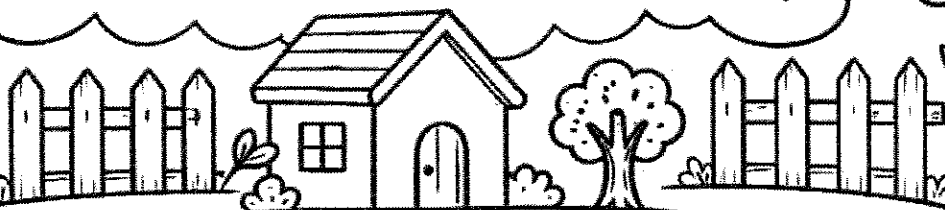

Maths

Which two pictures are the same? Match and colour.

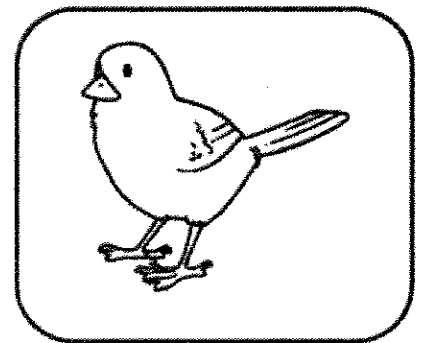
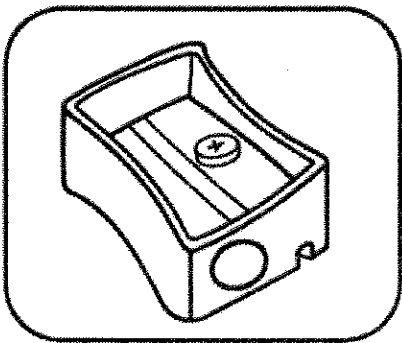
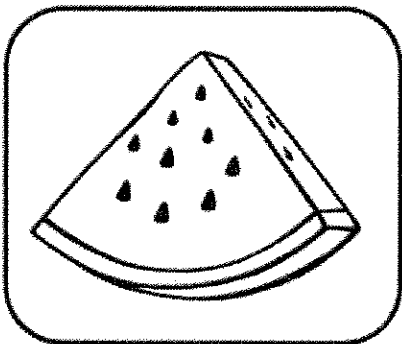
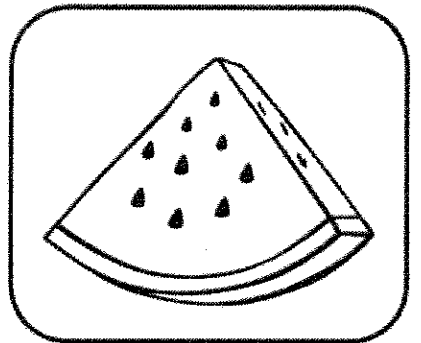
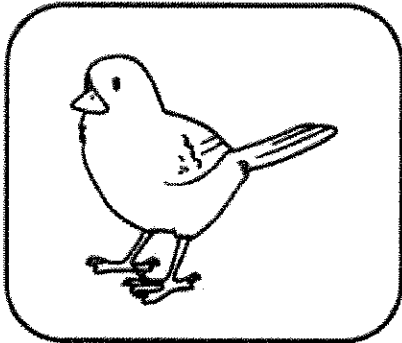
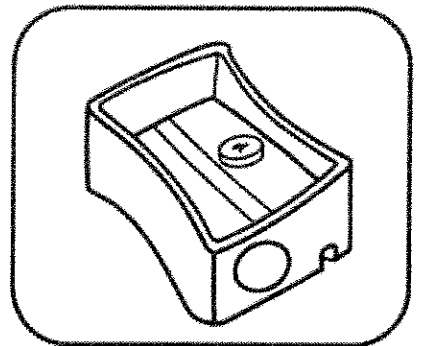

Match the pictures to its shadow

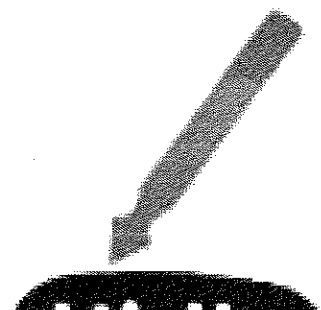
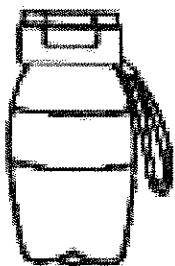
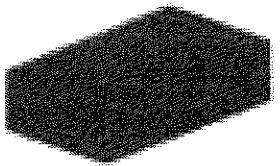
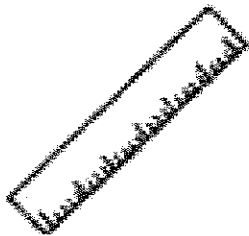
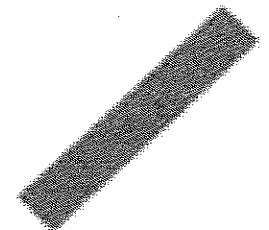
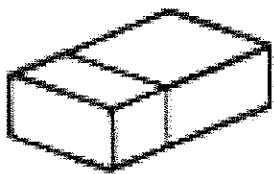
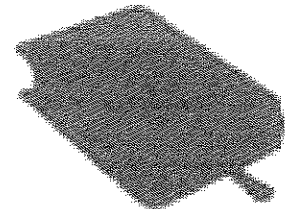
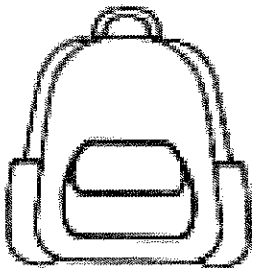
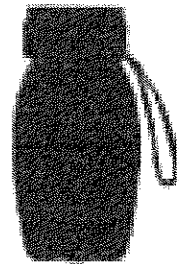
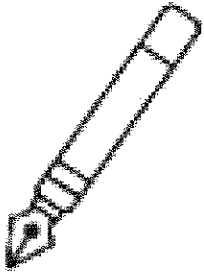
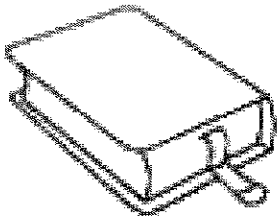

Count the picture and colour the correct number below.

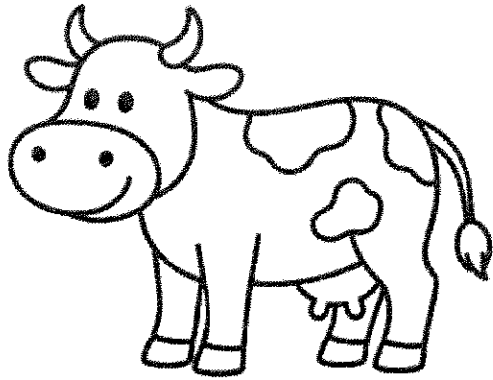

① ② ③

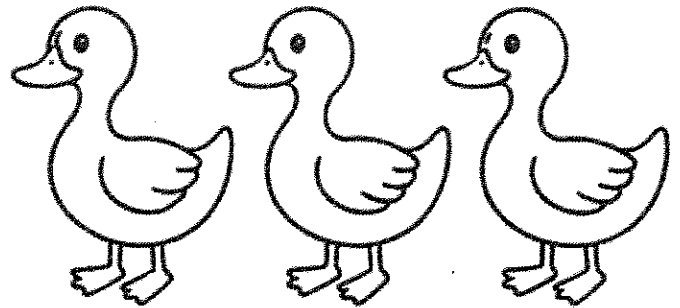

① ② ③

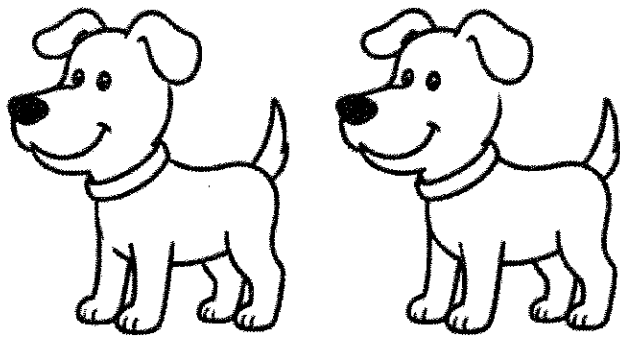

① ② ③

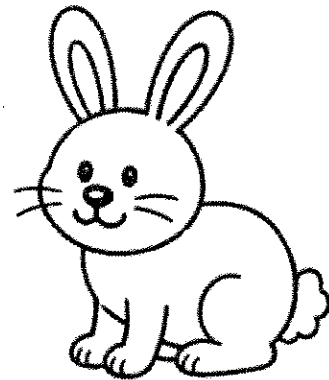

① ② ③

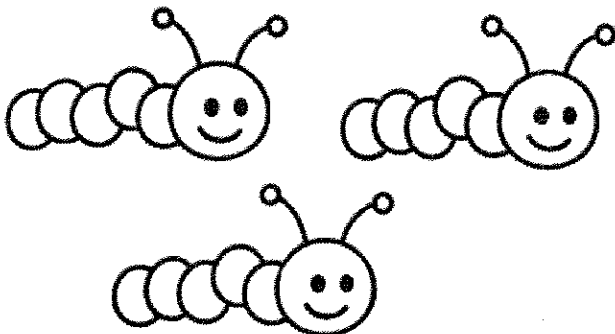

① ② ③

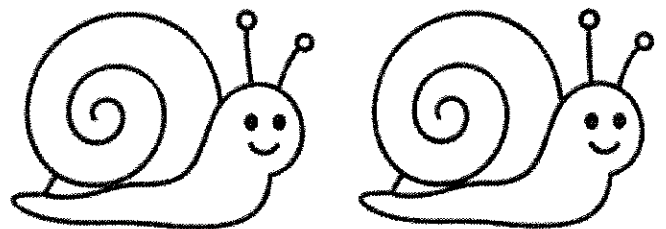

① ② ③

Draw a line to connect each picture with its other half.

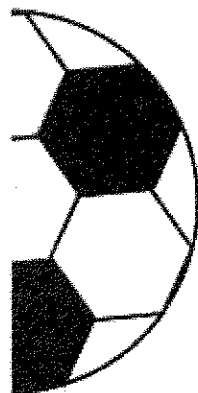
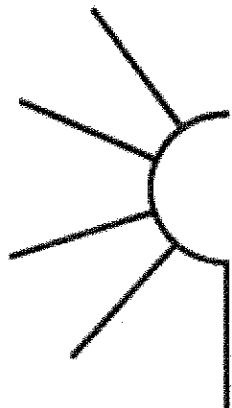
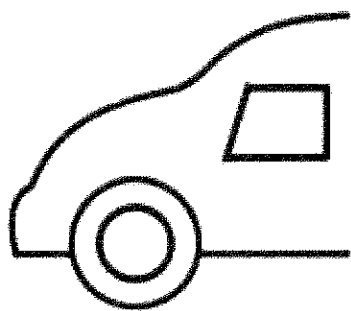
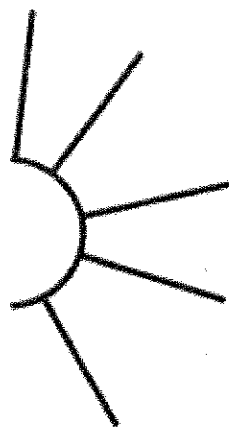
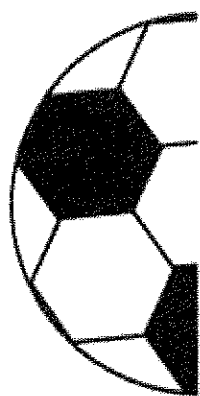
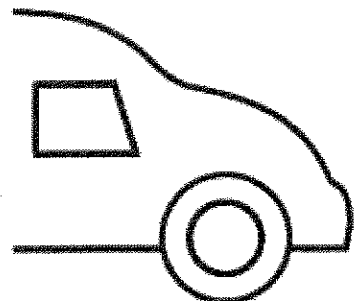
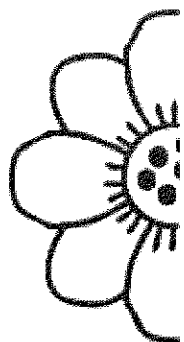

हिंदी

बिंदुओं को मिलाकर अक्षर का अभ्यास करिए।

क

क क क क क क

ख

ख ख ख ख ख ख

ग

ग ग ग ग ग ग

घ

घ घ घ घ घ घ

ङ

ङ ङ ङ ङ ङ ङ

च

च च च च च च

छ

छ छ छ छ छ छ

ज

ज ज ज ज ज ज

सही अक्षर पर गोला लगाओ (क - न)

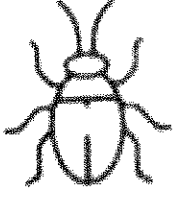

ड ख ठ

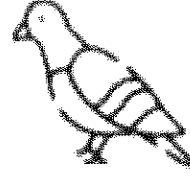

क ज ट



द न झ



ध न घ

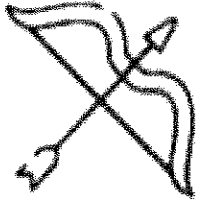

छ ध ढ



थ क द



च ग न



च छ झ



द घ ज



ठ ड ट



ड त घ

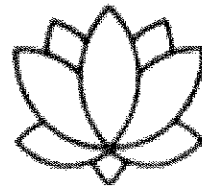

क द छ

★ 'क' को पहचानिए और बिंदुओं को मिलाइए। ★

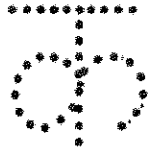
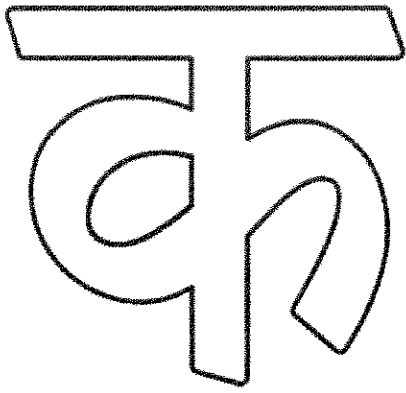

★ चित्रों को उनके सही नामों से मिलाइए। ★



कछुआ

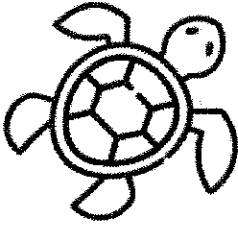

कबूतर



कमल

★ नीचे दिए गए अक्षरों में से 'क' को पहचानकर गोला लगाइए। ★

क

ओ

क

अ

ओ

आ

क

ओ

अं

क

क

ओ

इ

क

उ

अः

क

उ

ओ

क

अक्षरो का चित्रों से मिलान करें।

ग

ब

छ

झ

व

ब

ध

थ

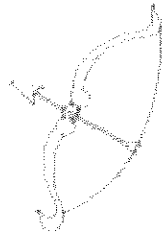
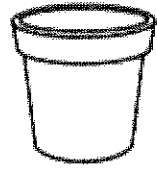
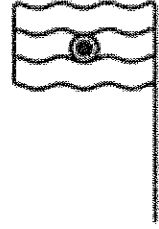

बिंदुओं को मिलाकर चित्र को पूरा करिए और रंग भरिए।

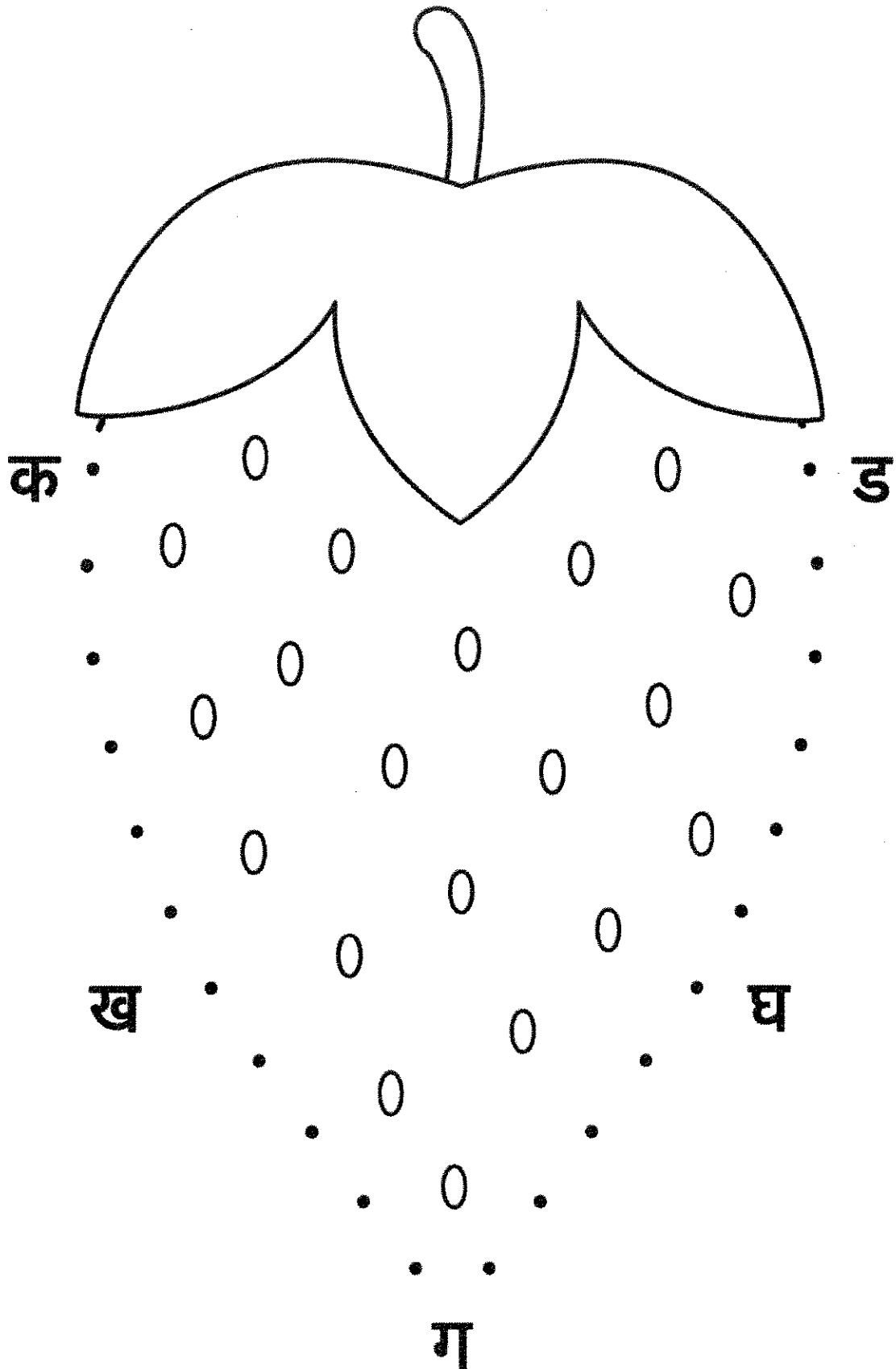

Subject - English

Trace the lines.

Trace the lines carefully from the pictures to the dots.

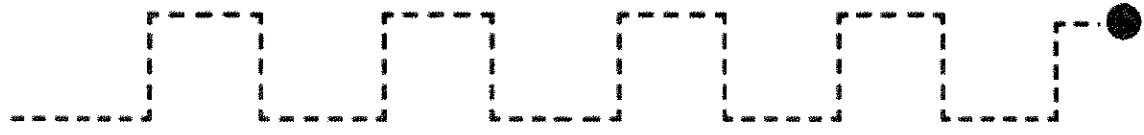
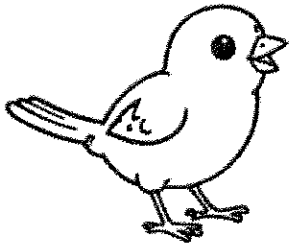
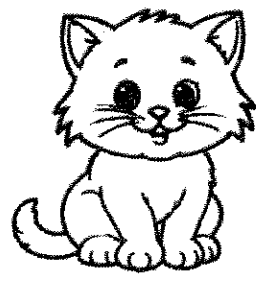
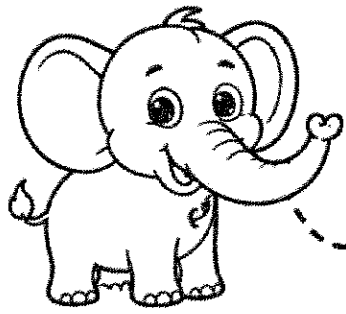
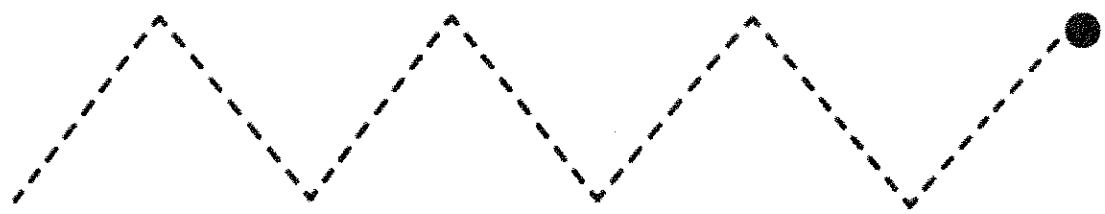
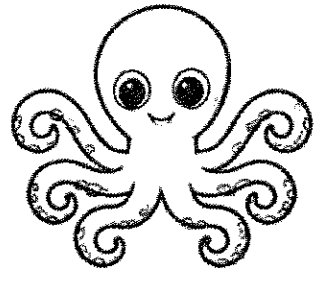
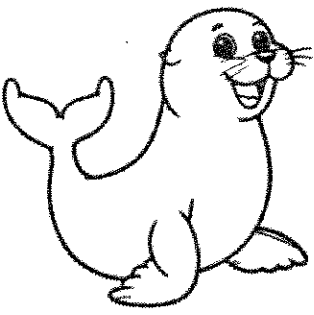

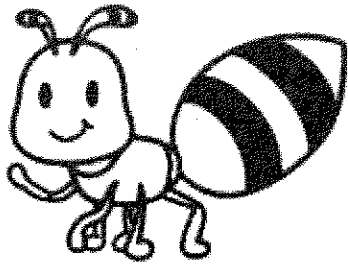

Ant

Aa

Aa

Aa

Aa

A

A

A

A

A

A

a

a

a

a

a

a

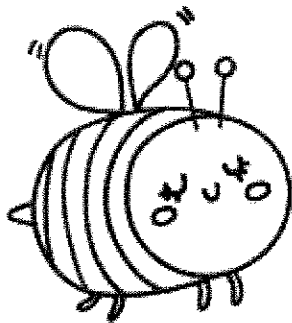

Bee

Bb

Bb

Bb

Bb

B

B

B

B

B

B

b

b

b

b

b

b

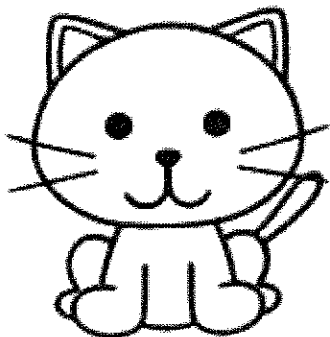

Cat

Cc

Cc

Cc

Cc

C

C

C

C

C

C

c

c

c

c

c

c

Match The Alphabet

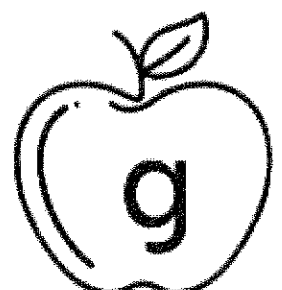
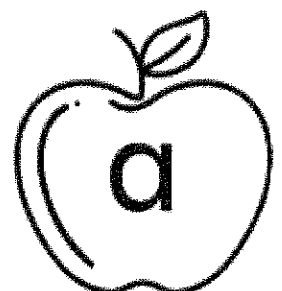
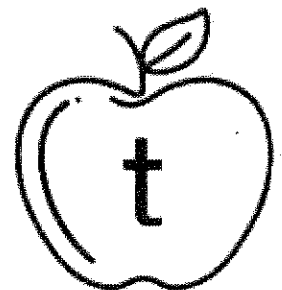
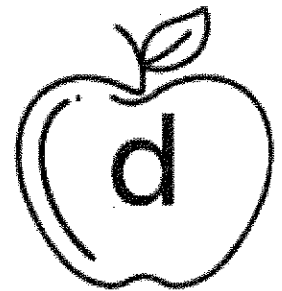
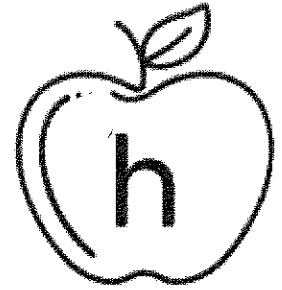
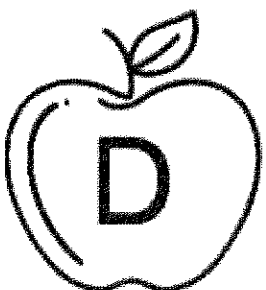
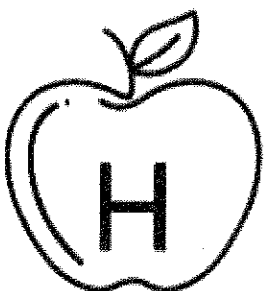
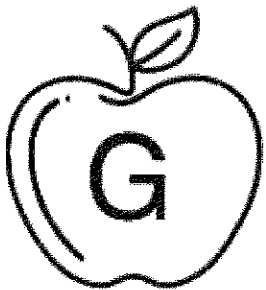
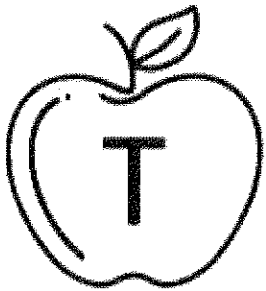
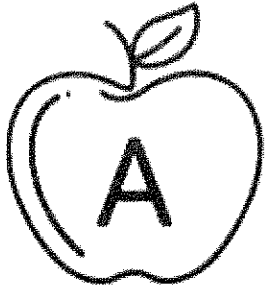

Trace the dots and complete the picture.

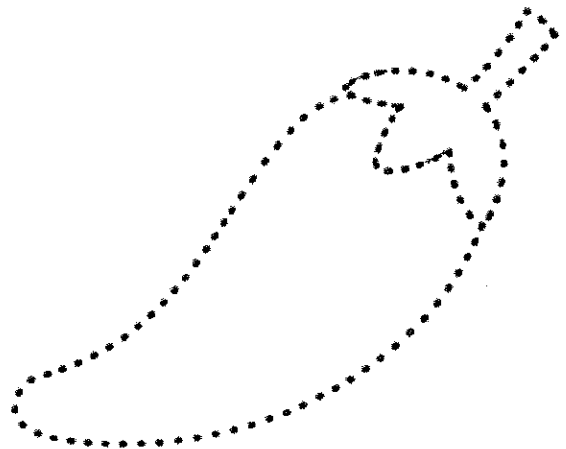
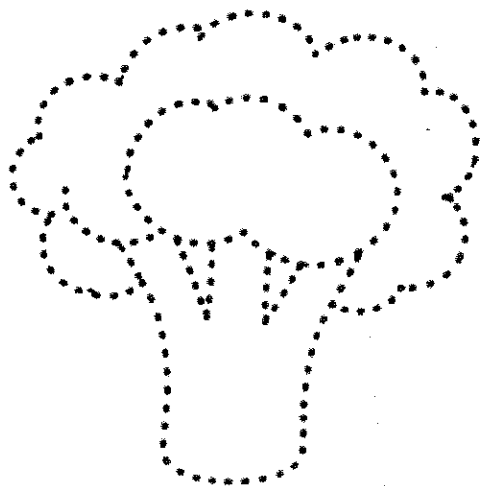
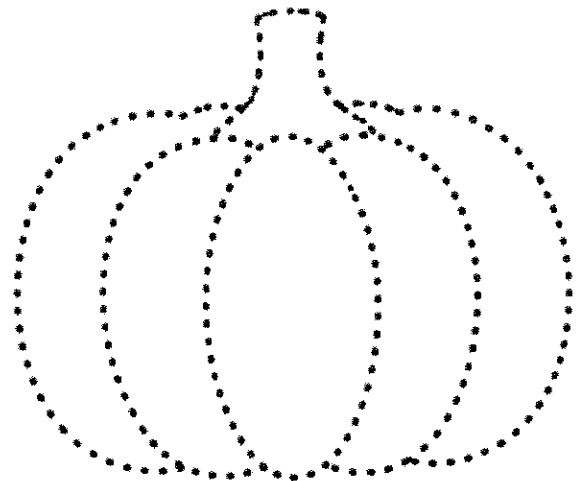
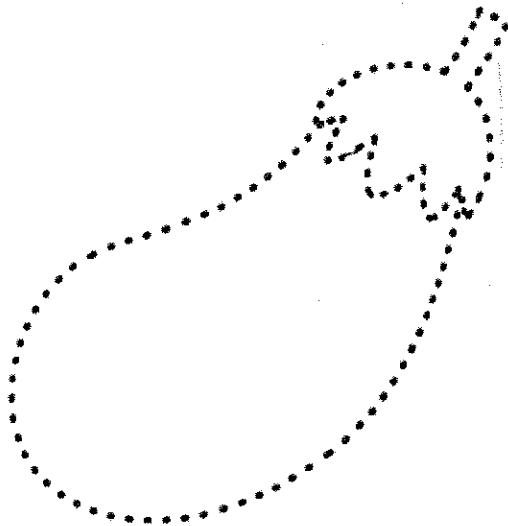
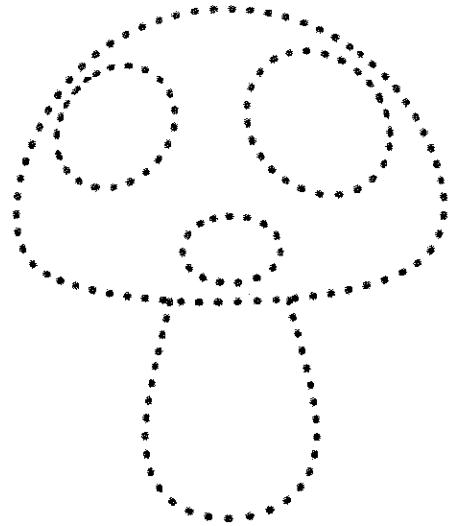
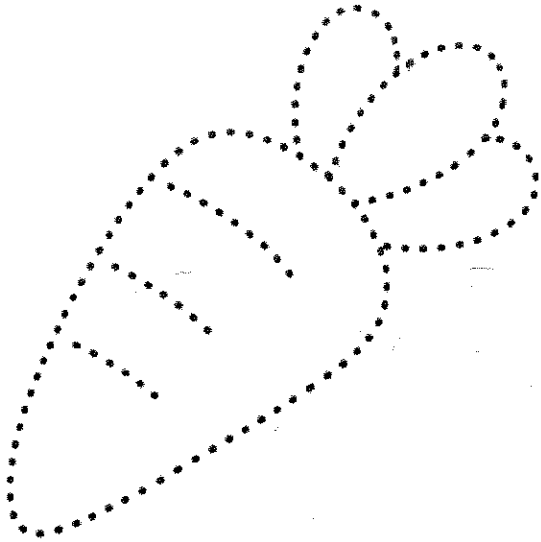



PROJECT WORK



1.

English - Paste pictures of sense organs in scrapbook.



2.

Hindi - 'क' और 'ख' वाले शब्दों के चित्रों को स्कैपबुक में चिपकाएँ।



3.

Maths - Paste big and small things in scrapbook.

